

Open Research Online

The Open University's repository of research publications and other research outputs

The problem of offset in acoustic pulse reflectometry

Conference or Workshop Item

How to cite:

Sharp, David B. and Li, Aijun (2007). The problem of offset in acoustic pulse reflectometry. In: Acta Acustica united with Acustica, 91(4) pp. 789–796.

For guidance on citations see [FAQs](#).

© 2007 The Authors

Version: Accepted Manuscript

Copyright and Moral Rights for the articles on this site are retained by the individual authors and/or other copyright owners. For more information on Open Research Online's [data policy](#) on reuse of materials please consult the policies page.

oro.open.ac.uk

THE PROBLEM OF OFFSET IN ACOUSTIC PULSE REFLECTOMETRY

David Sharp, Aijun Li

*Technology Faculty, Open University, Walton Hall, Milton Keynes, MK7 6AA, UK.
d.sharp@open.ac.uk*

Abstract

Acoustic pulse reflectometry has become established as a useful non-invasive technique for measuring a variety of duct properties. A sound pulse is injected into the duct under investigation and the resultant reflections are recorded. Suitable analysis of the reflections yields the input impulse response of the duct, from which both its input impedance and its internal dimensions can be calculated. However, an input impulse response measurement made using acoustic pulse reflectometry generally contains an offset. Unless this offset is removed, the application of a bore reconstruction algorithm results in a calculated duct profile which expands or contracts spuriously.

In this paper, the offset in an input impulse response measurement is shown to consist of both constant and time-varying components. Methods of preventing or removing these DC and time-varying offsets are proposed and subsequent improvements to the bore reconstruction accuracy are demonstrated.

INTRODUCTION

Acoustic pulse reflectometry has become established as a useful non-invasive method of measuring ducts of varying cross-section. In the medical field, the technique is used to monitor airway and ear canal dimensions [Fredberg et al, 1980; Marshall et al, 1991; Joswig, 1993]. Meanwhile, instrument makers and acousticians employ the technique to establish the bore dimensions of wind instruments [Watson and Bowsher, 1988; Sharp, 1996; Buick et al, 2002; Sharp et al, 2003].

Primarily, acoustic pulse reflectometry enables the measurement of the input impulse response of a duct. The application of a suitable algorithm to the input impulse response then yields the bore profile of the duct. However, the input impulse response measurement generally contains an offset which, unless removed, causes the calculated duct profile to expand or contract spuriously.

In this paper, the origin and nature of the offset in the input impulse response of a duct measured using acoustic pulse reflectometry is examined. Methods of preventing or removing the offset are investigated and subsequent improvements to the accuracy of the bore profile calculation are demonstrated.

ACOUSTIC PULSE REFLECTOMETRY TECHNIQUE

The standard acoustic pulse reflectometry technique has previously been described in detail in [Sharp, 1996; Sharp, 1998]. To aid understanding later in the paper, the basic principles are recapitulated in this section.

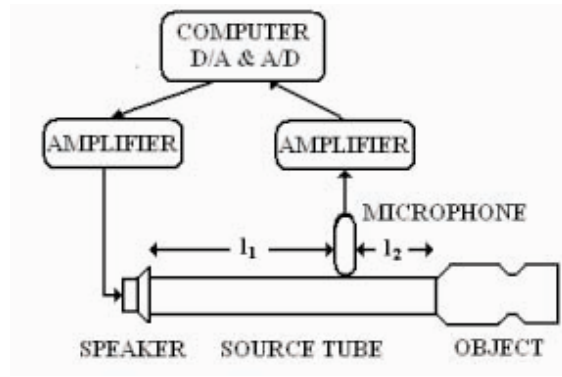

Figure 1: Schematic diagram of standard acoustic pulse reflectometer

Figure 1 shows a schematic diagram of a standard acoustic pulse reflectometer. An electrical pulse produced by a D/A converter is amplified and used to drive a compression-driver loudspeaker. The resultant sound pulse travels along a source tube into the duct under test. A microphone in the source tube wall records the reflections returning from the duct. The microphone signal is amplified, sampled by an A/D converter and stored on a PC.

To obtain the input impulse response of the duct, the recorded reflections are deconvolved with the input pulse shape. This is achieved by dividing the reflection signal by the input pulse in the frequency domain:

$$IIR(\omega_k) = \frac{R(\omega_k)}{I(\omega_k)} \quad (1)$$

where ω_k is the k th sample of the discretised angular frequency, $I(\omega_k)$ is the spectrum of the input pulse, $R(\omega_k)$ is the spectrum of the duct reflections, and $IIR(\omega_k)$ is the spectrum of the input impulse response. Performing an inverse FFT on $IIR(\omega_k)$ then gives the input impulse response $iir(t_n)$ in the time domain.

Finally, the application of a bore reconstruction algorithm (such as the lossy-layer peeling algorithm developed by [Amir et al, 1995]) enables the internal dimensions of the duct to be calculated from the measured input impulse response.

EFFECT OF OFFSET ON BORE RECONSTRUCTION

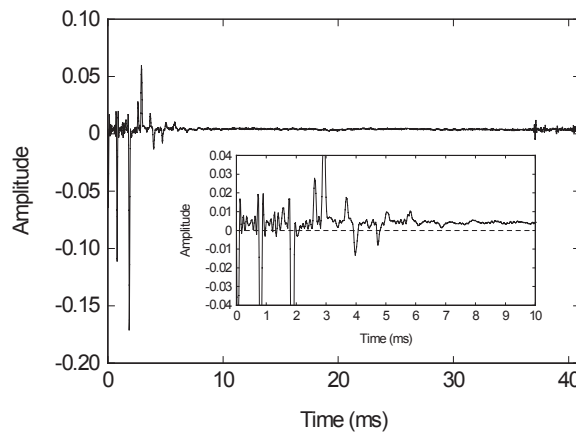

Figure 2: Input impulse response of stepped tube

Figure 2 shows the input impulse response of a stepped tube measured using acoustic pulse reflectometry. The stepped tube comprises a 130 mm long cylindrical section of 6.20 mm radius and a 180 mm long cylindrical section of 9.45 mm radius. Close examination reveals that the measured input impulse response contains an offset (this is particularly clear in the inset). In this case, the input impulse response is shifted above the $y = 0$ line by, on average, a value of approximately 0.005.

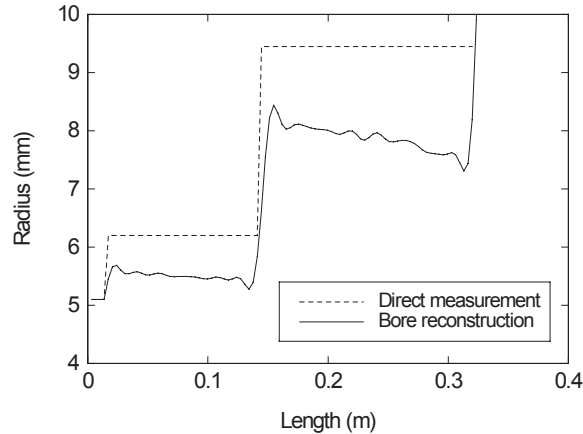

Figure 3: Bore reconstruction of stepped tube

The effect of the offset on the bore reconstruction can be seen in Figure 3. In the reconstructed profile, calculated by applying the lossy layer-peeling algorithm to the input impulse response of Figure 2, the radius of each section of the stepped tube decreases with distance along the tube rather than staying constant.

To obtain an accurate reconstruction, the input impulse response must be free of offset before application of the layer-peeling algorithm.

ANALYSIS OF OFFSET COMPOSITION

According to the definition of the inverse discrete Fourier transform, the experimentally measured input impulse response can be expressed as:

$$iir(t_n) = \frac{1}{N} \sum_{k=0}^{N-1} IIR(\omega_k) e^{j\omega_k t_n} = \frac{IIR(0)}{N} + \frac{1}{N} \sum_{k=1}^{N-1} IIR(\omega_k) e^{j\omega_k t_n} \quad (2)$$

where $IIR(0)$ is the first sample (the 0 Hz value) of the input impulse response spectrum and N is the total number of sample points. From equation (2), it can be seen that $iir(t_n)$ consists of both a constant component and a number of sinusoidal components.

The experimentally measured input impulse response can also be written as:

$$iir(t_n) = iir_r(t_n) + \Delta \quad (3)$$

where

$$iir_r(t_n) = \frac{IIR_r(0)}{N} + \frac{1}{N} \sum_{k=1}^{N-1} IIR_r(\omega_k) e^{j\omega_k t_n} \quad (4)$$

represents the actual true value of the input impulse response and Δ represents the experimental error, or offset, in the measurement.

By rearranging and combining equations (2), (3) and 4), the offset can be written:

$$\Delta = \frac{IIR(0) - IIR_{tr}(0)}{N} + \frac{1}{N} \sum_{k=1}^{N-1} [IIR(\omega_k) - IIR_{tr}(\omega_k)] e^{j\omega_k t_n} \quad (5)$$

It can be seen that the offset in the experimentally measured input impulse response arises from the incorrect measurement of both constant and sinusoidal components. That is, the total offset Δ comprises a DC offset Δ_1 and a time-varying offset Δ_2 , with

$$\Delta_1 = \frac{IIR(0) - IIR_{tr}(0)}{N} \quad (6)$$

$$\Delta_2 = \frac{1}{N} \sum_{k=1}^{N-1} [IIR(\omega_k) - IIR_{tr}(\omega_k)] e^{j\omega_k t_n} \quad (7)$$

DC OFFSET Δ_1

Origin of the DC offset

According to equation (6), a DC offset is introduced into an input impulse response measurement if the experimentally determined value of $IIR(0)$ doesn't match the true value exactly. From equation (1) it can be seen that

$$IIR(0) = \frac{R(0)}{I(0)} \quad (8)$$

Therefore, any error in the value of $IIR(0)$ could be due to an error in the measurement of $I(0)$ or $R(0)$. Alternatively, it could be the result of a division by zero, which would be the case if $I(0)$ were vanishingly small.

Attempting to prevent the DC offset

One possible cause of the DC offset is an error in the measurement of $I(0)$ or $R(0)$. That is, the input pulse and duct reflection measurements could themselves contain a DC offset. To prevent this happening, a second set of reflectometry measurements can be made using a negative pressure input pulse. By inverting the second set of measurements and averaging with the first set, the input pulse and duct reflections can be determined with no DC offset present [Li, 2004; Li et al, 2005]. However, even when this is done, there still remains a DC offset in the resultant input impulse response.

Another possible cause of the DC offset in an input impulse response measurement is that the value of $I(0)$ is vanishingly small, leading to a division by zero error when equation (8) is implemented. This is the case if the input pulse doesn't exhibit strong polarity and is certainly true of the pulses produced by a standard reflectometer. Although various methods have been suggested for driving a loudspeaker in such a way as to produce more polarised pressure pulses [Marshall, 1990], in reality a

conventional loudspeaker cannot produce a DC pressure. The consequence is that the calculation of $IIR(0)$ does indeed involve a division by zero, or near-zero, resulting in numerical instability. This is the main cause of the DC offset in an input impulse response measurement.

Removing the DC offset by calibration

Although measures for preventing the introduction of DC offset into the input impulse response have proved unsuccessful, it is still possible to remove the DC offset by calibration. The calibration procedure involves inserting a 50 cm long cylindrical tube between the reflectometer source tube and the duct under test prior to the measurement. The internal radius of this 'DC tube' should be similar to that of the source tube. The reflectometry measurements are carried out in the usual way. However, as there should be no signal reflected back from the DC tube, approximately the first three milliseconds of the input impulse response should be zero. Finding the average value of the measured input impulse response over this range thus gives the DC offset. This value can then be subtracted from the whole input impulse response.

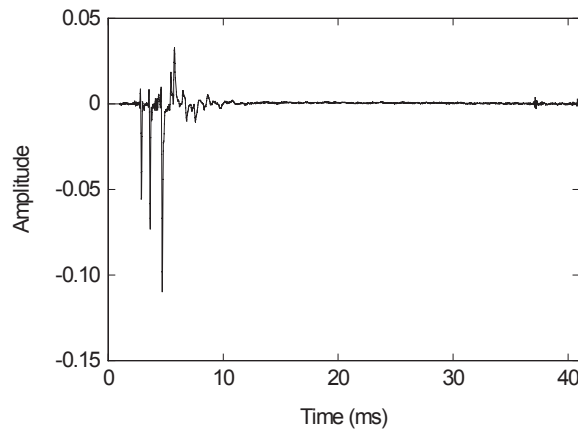

Figure 4: Input impulse response of stepped tube (after calibration to remove DC offset)

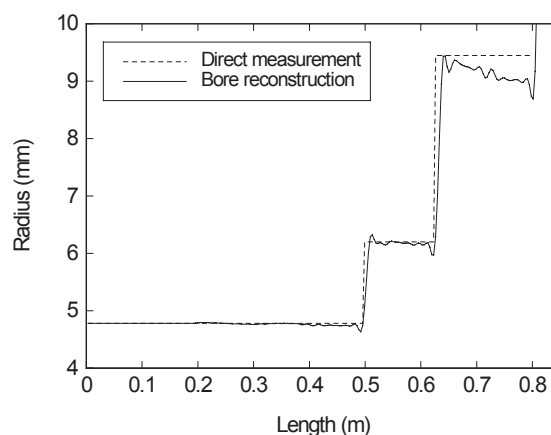

Figure 5: Bore reconstruction of stepped tube (calculated from input impulse response with no DC offset)

Figure 4 shows the input impulse response of the stepped tube (with the DC tube in place) after the DC offset has been removed using this calibration procedure. The

result of applying the layer-peeling algorithm to this input impulse response can be seen in Figure 5. The first 50 cm of the reconstruction is the DC tube. Although the DC tube and the first section of the stepped tube have been accurately reconstructed, the radius of the second section of the stepped tube decreases with distance. Even though the DC offset has been successfully removed, there is still a time-varying offset present in the input impulse response. For the DC tube calibration procedure to be fully effective, the input impulse response must be free of any time-varying offset.

TIME-VARYING OFFSET Δ_2

Origin of the time-varying offset

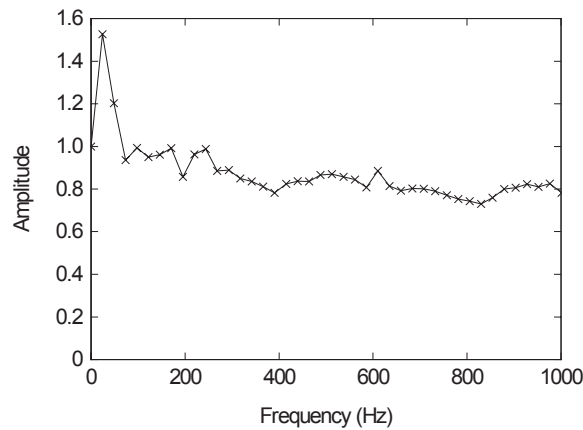

Figure 6: Frequency spectrum of stepped tube input impulse response (from measurements using compression-driver loudspeaker)

Referring back to equation (7), a time-varying offset is introduced into an input impulse response measurement if the sinusoidal components are incorrectly determined. Figure 6 shows the first 1000 Hz of the frequency spectrum of the stepped tube input impulse response displayed in Figure 4. Since each element of $IIR(\omega_k)$ represents a reflection coefficient, at no frequency should the magnitude exceed 1. However, examination of Figure 6 reveals that the amplitude of $IIR(\omega_k)$ is greater than 1 at frequencies of 24.4 Hz and 48.8 Hz. As the input pulse has little energy below 50 Hz (due to the poor response of the compression-driver loudspeaker at low frequencies), there is a division-by-noise error when calculating $IIR(\omega_k)$ at these frequencies.

Preventing time-varying offset

To improve the measurement of the input impulse response at low frequencies, the standard reflectometry procedure is repeated (again with the DC tube in place). This time, however, a bass loudspeaker, with a good low frequency response, is used to generate the input pulse. When the input impulse response is calculated using these measurements, the magnitude of $IIR(\omega_k)$ remains less than 1 below 50 Hz.

A new input impulse response spectrum is constructed by combining the low frequency components of $IIR(\omega_k)$ measured using the bass loudspeaker with the higher frequency components measured using the compression-driver loudspeaker. Figure 7 shows the combined input impulse response spectrum for the stepped tube with DC tube.

Performing an inverse FFT on the combined $IIR(\omega_k)$ then yields the input impulse response in the time domain, $iir(t_n)$, with no time-varying offset present. Any

DC offset can then be removed by carrying out the DC tube calibration procedure as before. Figure 8 shows the calculated duct profile that results when the input impulse response spectrum of Figure 7 is inverse Fourier transformed, any DC offset is removed by calibration, and then the layer-peeling reconstruction algorithm is applied. The radii of both cylindrical sections of the stepped tube now remain constant with distance and show a good agreement with the actual directly measured values.

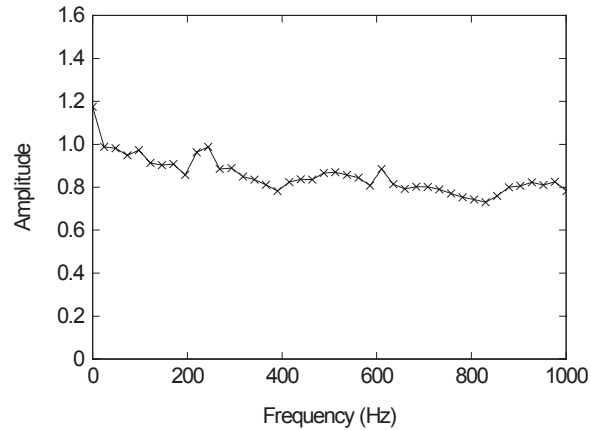

Figure 7: Frequency spectrum of stepped tube input impulse response (from combination of compression-driver and bass loudspeaker measurements)

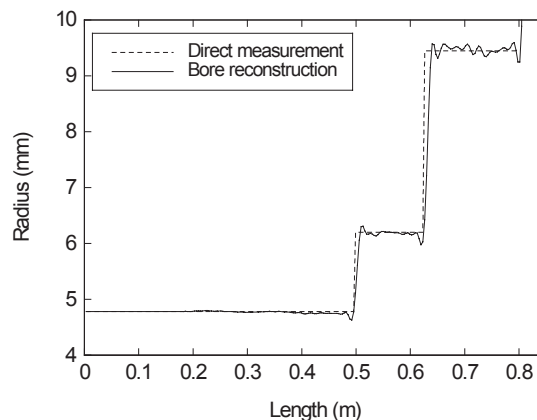

Figure 8: Bore reconstruction of stepped tube (calculated from input impulse response with no DC offset and no time-varying offset)

CONCLUSIONS

The offset that is introduced into input impulse response measurements made using acoustic pulse reflectometry has been shown to consist of two elements; a DC offset and a time-varying offset. By carrying out a supplementary set of reflectometry measurements, using a bass loudspeaker to improve the low frequency content of the input impulse response, the time-varying offset can be eliminated. Once this has been done, the DC offset can then be removed by calibration.

These adaptations to the acoustic pulse reflectometry technique result in input impulse response measurements which are free of any offset. This, in turn, leads to bore reconstructions of higher accuracy and reproducibility. As a final demonstration of this,

Figure 9 shows a bore reconstruction of a modern reproduction of a Renaissance cornett, manufactured by Jeremy West, calculated from an input impulse response measurement free of any offset. Although the DC tube has not been plotted in this instance, the first few centimetres of the reconstruction do show the coupler used to connect the cornett to the DC tube. Both at the mouthpiece end and at the far end of the instrument, the reconstructed cornett profile agrees with the actual radius of the bore to within 0.01 mm.

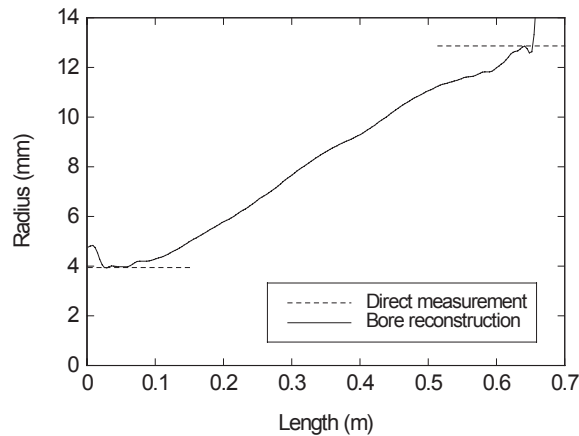

Figure 9: Bore reconstruction of modern reproduction of Renaissance cornett

REFERENCES

- Amir N.; Rosenhouse, G.; Shimony, U. (1995). "A discrete model for tubular acoustic systems with varying cross section – the direct and inverse problems. Parts I and II. Theory and experiment." *Acustica* 81, pp. 450-474.
- Buick, J.M.; Kemp, J.; Sharp, D.B.; van Walstijn, M.; Campbell, D.M.; Smith, R.A. (2002). "Distinguishing between similar tubular objects using pulse reflectometry: a study of trumpet and cornet leadpipes." *Meas. Sci. Tech.* 13, pp. 750-757.
- Fredberg, J.J.; Wohl, M.E.B.; Glass, G.M.; Dorkin, H.L. (1980). "Airway area by acoustic reflections measured at the mouth." *J. Appl. Physiol.* 48, pp. 749-758.
- Joswig, M. (1993). "Impulse response measurement of individual ear canals and impedances at the eardrum in man." *Acustica* 77, pp. 270-282.
- Li, A. (2004). "Improvements to the acoustic pulse reflectometry technique for measuring duct dimensions." *PhD thesis*. Open University, UK.
- Li, A.; Sharp, D.B. (2005). "The problem of offsets in measurements made using acoustic pulse reflectometry." *Acustica* 99, pp. 789-796.
- Marshall, I. (1990). "The production of acoustic impulses in air." *Meas. Sci. Tech.* 1, pp. 413-418.
- Marshall, I.; Rogers, M.; Drummond, G. (1991). "Acoustic reflectometry for airway measurement." *Clin. Phys. Physiol. Meas.* 12, pp. 131-141.
- Sharp, D.B. (1996). "Acoustic pulse reflectometry for the measurement of musical wind instruments." *PhD thesis*. University of Edinburgh, UK.
- Sharp, D.B. (1998). "Increasing the length of tubular object that can be measured using acoustic pulse reflectometry." *Meas. Sci. Tech.* 9, pp. 1469-1479.
- Sharp, D.B.; Wright, H.A.K.; Ring, W. (2003). "An acoustical investigation into the effect of the crook profile on the sound produced by the bassoon." *Acustica* 89, pp.137-144.
- Watson A.P.; Bowsher J.M. (1988). "Impulse measurements on brass musical instruments." *Acustica* 66, pp.170-174.